

OWNER'S MANUAL

KOHLER COURAGE SV470-SV620 VERTICAL CRANKSHAFT



KOHLER
ENGINES

Safety Precautions

To ensure safe operation please read the following statements and understand their meaning. Also refer to your equipment owner's manual for other important safety information. This manual contains safety precautions which are explained below. Please read carefully.

WARNING

Warning is used to indicate the presence of a hazard that *can* cause *severe* personal injury, death, or substantial property damage if the warning is ignored.

CAUTION



Caution is used to indicate the presence of a hazard that *will* or can cause *minor* personal injury or property damage if the caution is ignored.

NOTE

Note is used to notify people of installation, operation, or maintenance information that is important but not hazard-related.



For Your Safety!

These precautions should be followed at all times. Failure to follow these precautions could result in injury to yourself and others.

 WARNING

Explosive Fuel can cause fires and severe burns. Do not fill the fuel tank while the engine is hot or running.



Explosive Fuel!

Gasoline is extremely flammable and its vapors can explode if ignited. Store gasoline only in approved containers, in well ventilated, unoccupied buildings, away from sparks or flames. Do not fill the fuel tank while the engine is hot or running, since spilled fuel could ignite if it comes in contact with hot parts or sparks from ignition. Do not start the engine near spilled fuel. Never use gasoline as a cleaning agent.

 WARNING

Rotating Parts can cause severe injury. Stay away while engine is in operation.



Rotating Parts!

Keep hands, feet, hair, and clothing away from all moving parts to prevent injury. Never operate the engine with covers, shrouds, or guards removed.

 WARNING

Hot Parts can cause severe burns. Do not touch engine while operating or just after stopping.

Hot Parts!

Engine components can get extremely hot from operation. To prevent severe burns, do not touch these areas while the engine is running, or immediately after it is turned off. Never operate the engine with heat shields or guards removed.

 CAUTION

Electrical Shock can cause injury. Do not touch wires while engine is running.

Electrical Shock!

Never touch electrical wires or components while the engine is running. They can be sources of electrical shock.

California Proposition 65 Warning
<i>Engine exhaust from this product contains chemicals known to the State of California to cause cancer, birth defects, or other reproductive harm.</i>

Safety Precautions (Cont.)

 WARNING



Accidental Starts can cause severe injury or death. Disconnect and ground spark plug lead before servicing.

Accidental Starts!

Disabling engine. Accidental starting can cause severe injury or death.



Before working on the engine or equipment, disable the engine as follows:

- 1) Disconnect the spark plug lead(s).*
- 2) Disconnect negative (-) battery cable from battery.*

 WARNING

Carbon Monoxide can cause severe nausea, fainting or death. Avoid inhaling exhaust fumes, and never run the engine in a closed building or confined area.

Lethal Exhaust Gases!

Engine exhaust gases contain poisonous carbon monoxide. Carbon monoxide is odorless, colorless, and can cause death if inhaled. Avoid inhaling exhaust fumes, and never run the engine in a closed building or confined area.

 WARNING

Explosive Gas can cause fires and severe acid burns. Charge battery only in a well ventilated area. Keep sources of ignition away.

Explosive Gas!

Batteries produce explosive hydrogen gas while being charged. To prevent a fire or explosion, charge batteries only in well ventilated areas. Keep sparks, open flames, and other sources of ignition away from the battery at all times. Keep batteries out of the reach of children. Remove all jewelry when servicing batteries.

Before disconnecting the negative (-) ground cable, make sure all switches are OFF. If ON, a spark will occur at the ground cable terminal which could cause an explosion if hydrogen gas or gasoline vapors are present.

Congratulations – You have selected a fine four-cycle, single cylinder, air-cooled engine. Kohler designs long life strength and on-the-job durability into each engine...making a Kohler engine dependable...dependability you can count on. Here are some reasons why:

- Efficient twin cam, overhead valve design with full pressure lubrication, provides maximum power, torque, and reliability under all operating conditions.
- Dependable, maintenance free electronic ignition ensures fast, easy starts time after time.
- A reciprocating balance system ensures smooth running and low vibration.
- Kohler engines are easy to service. All routine service areas (like the dipstick and oil fill, air cleaner, and carburetor) are easily and quickly accessible.
- Parts subject to the most wear and tear (like the cylinder liner) are made from precision formulated cast iron for longer life.
- Every Kohler engine is backed by a worldwide network of over 10,000 distributors and dealers. Service support is just a phone call away. Call 1-800-544-2444 (U.S. & Canada) for Sales & Service assistance. Or visit www.KohlerEngines.com.

To keep your engine in top operating condition, follow the maintenance procedures in this manual.

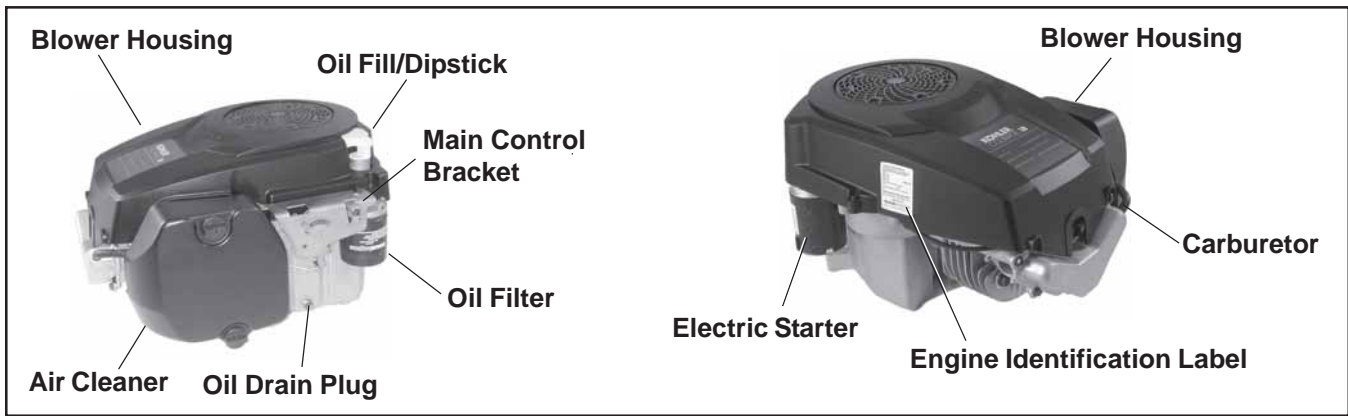

Figure 1. Typical COURAGE[®] Series Vertical Shaft Engine.

Oil Recommendations

Using the proper type and weight of oil in the crankcase is extremely important. So is checking oil daily and changing oil regularly. Failure to use the correct oil, or using dirty oil, causes premature engine wear and failure.

Oil Type

Use high quality detergent oil of API (American Petroleum Institute) service class SG, SH, SJ or higher. Select the viscosity based on the air temperature at the time of operation as shown in the following table.

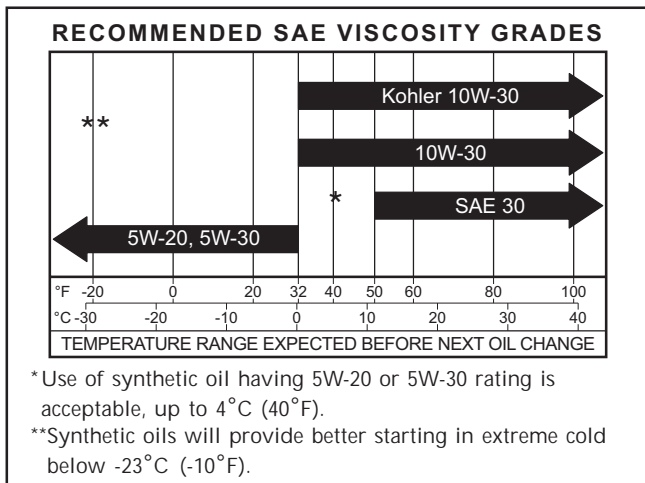

Figure 2. Viscosity Grades Table.

NOTE: Using other than service class SG, SH, SJ or higher oil or extending oil change intervals longer than recommended can cause engine damage.

NOTE: Synthetic oils meeting the listed classifications may be used with oil changes performed at the recommended intervals. However to allow piston rings to properly seat, a new or rebuilt engine should be operated for at least 50 hours using standard petroleum based oil before switching to synthetic oil.

A logo or symbol on oil containers identifies the API service class and SAE viscosity grade. See Figure 3.



Figure 3. Oil Container Logo.

Refer to Maintenance Instructions beginning on page 8 for detailed oil check, oil change, and oil filter change procedures.

Fuel Recommendations



WARNING: Explosive Fuel!

Gasoline is extremely flammable and its vapors can explode if ignited. Store gasoline only in approved containers, in well ventilated, unoccupied buildings, away from sparks or flames. Do not fill the fuel tank while the engine is hot or running, since spilled fuel could ignite if it comes in contact with hot parts or sparks from ignition. Do not start the engine near spilled fuel. Never use gasoline as a cleaning agent.

General Recommendations

Purchase gasoline in small quantities and store in clean, approved containers. A container with a capacity of 2 gallons or less with a pouring spout is recommended. Such a container is easier to handle and helps eliminate spillage during refueling.

Do not use gasoline left over from the previous season, to minimize gum deposits in your fuel system and to ensure easy starting.

Do not add oil to the gasoline.

Do not overfill the fuel tank. Leave room for the fuel to expand.

Fuel Type

For best results use only clean, fresh, **unleaded** gasoline with a pump sticker octane rating of 87 or higher. In countries using the Research method, it should be 90 octane minimum.

Unleaded gasoline is recommended as it leaves less combustion chamber deposits. Leaded gasoline may be used in areas where unleaded is not available and exhaust emissions are not regulated. Be aware however, that the cylinder heads may require more frequent service.

Gasoline/Alcohol blends

Gasohol (up to 10% ethyl alcohol, 90% unleaded gasoline by volume) is approved as a fuel for Kohler engines. Other gasoline/alcohol blends including E20 and E85 are not to be used and not approved. Any failures resulting from use of these fuels will not be warranted.

Gasoline/Ether blends

Methyl Tertiary Butyl Ether (MTBE) and unleaded gasoline blends (up to a maximum of 15% MTBE by volume) are approved as a fuel for Kohler engine. Other gasoline/ether blends are not approved.

Engine Identification Numbers

When ordering parts, or in any communication involving an engine, always give the **Model**, **Specification**, and **Serial Numbers** of the engine.

The engine identification numbers appear on a decal affixed to the engine shrouding. Include letter suffixes, if there are any.

Record your engine identification numbers on the identification label (Figure 4) for future reference.



IMPORTANT ENGINE INFORMATION
 THIS ENGINE MEETS U.S. EPA PH2 AND EC STAGE II (SN:4) EMISSION REGS FOR SI SORE. NOT FOR SALE IN CALIFORNIA UNLESS PREEMPT PER SEC. 209 (e) (1) OF CAA.

FAMILY
TYPE APP
DISPL. (CC)
MODEL NO.
SPEC. NO.
SERIAL NO.
BUILD DATE
OEM PROD. NO.

EMISSION COMPLIANCE PERIOD:
 EPA: CARB:
 CERTIFIED ON:
 REFER TO OWNER'S MANUAL FOR HP RATING, SAFETY,
 MAINTENANCE AND ADJUSTMENTS
 1-800-544-2444 KohlerEngines.com
 KOHLER CO. KOHLER, WISCONSIN USA

 N11236



IMPORTANT ENGINE INFORMATION
 THIS ENGINE MEETS U.S. EPA PH2 AND CA 2008 AND LATER EXH EMISSION REGS FOR SI SORE. USING DELEGATED ASSEMBLY FOR AFTERTREATMENT.

FAMILY
TYPE APP
DISPL. (CC)
MODEL NO.
SPEC. NO.
SERIAL NO.
BUILD DATE
OEM PROD. NO.

EMISSION COMPLIANCE PERIOD:
 EPA: CARB:
 CERTIFIED ON:
 REFER TO OWNER'S MANUAL FOR HP RATING, SAFETY,
 MAINTENANCE AND ADJUSTMENTS
 1-800-544-2444 KohlerEngines.com
 KOHLER CO. KOHLER, WISCONSIN USA

 N11236

Figure 4. Engine Identification Label.

The Emission Compliance Period referred to on the Emission Control or Air Index label indicates the number of operating hours for which the engine has been shown to meet Federal and CARB emission requirements. The following table provides the Engine Compliance Period (in hours) associated with the category descriptor found on the certification label.

Emission Compliance Period (Hours)

EPA	Category C 250 Hours	Category B 500 Hours	Category A 1000 Hours
CARB	Moderate 125 Hours	Intermediate 250 Hours	Extended 500 Hours

Refer to certification label for engine displacement.

Exhaust Emission Control System for models SV470-SV620 is EM for U.S. EPA and Europe; PAIR for California Tier III.

Specifications

Model:	SV470	SV480	SV530	SV540
Bore:	94 (3.7)	94 (3.7)	94 (3.7)	94 (3.7)
Stroke:	86 (3.4)	86 (3.4)	86 (3.4)	86 (3.4)
Displacement:	597 (36.4)	597 (36.4)	597 (36.4)	597 (36.4)
Power (at 3600 RPM):	11.2 (15*)	11.9 (16*)	12.7 (17*)	13.4 (18*)
Compression Ratio:	8.5:1	8.5:1	8.5:1	8.5:1
Weight:	35.8 (79)	35.8 (79)	35.8 (79)	35.8 (79)
Oil Capacity w/filter:	1.5 (1.6)	1.5 (1.6)	1.5 (1.6)	1.5 (1.6)
Lubrication:	----- Full Pressure w/Full Flow Filter -----			
Model:	SV590	SV600	SV610	SV620
Bore:	94 (3.7)	94 (3.7)	94 (3.7)	94 (3.7)
Stroke:	86 (3.4)	86 (3.4)	86 (3.4)	86 (3.4)
Displacement:	597 (36.4)	597 (36.4)	597 (36.4)	597 (36.4)
Power (at 3600 RPM):	14.2 (19*)	14.9 (20*)	15.7 (21*)	16.4 (22*)
Compression Ratio:	8.5:1	8.5:1	8.5:1	8.5:1
Weight:	35.8 (79)	35.8 (79)	35.8 (79)	35.8 (79)
Oil Capacity w/filter:	1.5 (1.6)	1.5 (1.6)	1.5 (1.6)	1.5 (1.6)
Lubrication:	----- Full Pressure w/Full Flow Filter -----			

*Horsepower ratings exceed Society of Automotive Engineers Small Engine Test Code J1940. Actual engine horsepower is lower and affected by, but not limited to, accessories (air cleaner, exhaust, charging, cooling, fuel pump, etc.), application, engine speed and ambient operating conditions (temperature, humidity, and altitude). Kohler reserves the right to change product specifications, designs and equipment without notice and without incurring obligation.

Operating Instructions

Also read the operating instructions of the equipment this engine powers.

Pre-Start Checklist

- Check oil level. Add oil if low. Do not overfill.
- Check fuel level. Add fuel if low.
- Check cooling air intake areas and external surfaces of engine. Make sure they are clean and unobstructed.
- Check that the air cleaner components and all shrouds, equipment covers, and guards are in place and securely fastened.
- Check that any clutches or transmissions are disengaged or placed in neutral. This is especially important on equipment with hydrostatic drive. The shift lever must be exactly in neutral to prevent resistance which could keep the engine from starting.

3. A warm battery has much more starting capacity than a cold battery.
4. Use fresh winter grade fuel. NOTE: Winter grade gasoline has higher volatility to improve starting. Do not use gasoline left over from summer.

Starting

1. a. **For a Single-Lever Throttle/Choke Control:** Place the lever into **fast/choke on** position. See Figure 5.
- b. **For Separate Levers:** Place the throttle control **midway** between the **slow** and **fast** positions. Place the choke control into the **on** position.

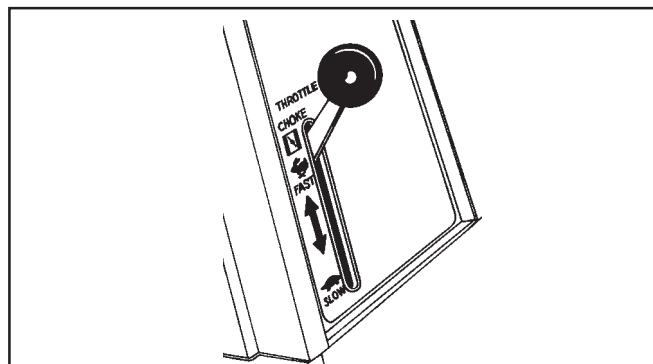

Figure 5. Throttle Position for Starting Engine with Single-Lever Control.



WARNING: Lethal Exhaust Gases!

Engine exhaust gases contain poisonous carbon monoxide. Carbon monoxide is odorless, colorless, and can cause death if inhaled. Avoid inhaling exhaust fumes, and never run the engine in a closed building or confined area.

Cold Weather Starting Hints

1. Be sure to use the proper oil for the temperature expected. See Figure 2 on page 4.
2. Declutch all possible external loads.

2. Make sure the equipment is in neutral.
3. Activate the starter switch. Release the switch as soon as the engine starts.

NOTE: Do not crank the engine continuously for more than 10 seconds at a time. If the engine does not start, allow a 60 second cool down period between starting attempts. Failure to follow these guidelines can burn out the starter motor.

NOTE: If the engine develops sufficient speed to disengage the starter but does not keep running (a false start), engine rotation must be allowed to come to a complete stop before attempting to restart the engine. If the starter is engaged while the flywheel is rotating, the starter pinion and flywheel ring gear may clash, resulting in damage to the starter.

If the starter does not turn the engine over, shut off starter immediately. Do not make further attempts to start the engine until the condition is corrected. Do not jump start using another battery (refer to Battery). See your Kohler Engine Service Dealer for trouble analysis.

4. For Operation - after the engine starts:
 - a. **For a Single-Lever Throttle/Choke Control:** Move the lever from the **fast/choke on** position and set the desired engine operating speed (between the **slow** and **fast** position).
 - b. **For Separate Levers:** Gradually move the choke control to the **off** position. If the engine is warm, the choke control can be returned to the **off** position as soon as the engine starts. If the engine is cold, it may be operated during the warm-up period, but it may be necessary to leave the choke partially **on** until the engine warms up.

Stopping

1. Remove the load by disengaging all PTO attachments.
2. a. **For engines without a shutdown solenoid:** Move the throttle to the **slow** or **low** idle position. Allow the engine to run at idle for 30-60 seconds; then stop the engine.

- b. **For engines equipped with a shutdown solenoid:** Position the throttle control between half and full throttle; then stop the engine.

Battery

A 12 volt battery is normally used. Refer to the operating instructions of the equipment this engine powers, for specific battery requirements.

If the battery charge is not sufficient to crank the engine, recharge the battery (see page 11).

Operating

Angle of Operation

This engine will operate continuously at angles up to 25°. Check oil level to assure crankcase oil level is at the "F" mark on the dipstick.

Refer to the operating instructions of the equipment this engine powers. Because of equipment design or application, there may be more stringent restrictions regarding the angle of operation.

NOTE: Do not operate this engine continuously at angles exceeding 25° in any direction. Engine damage could result from insufficient lubrication.

Cooling

NOTE: If debris builds up on the grass screen or other cooling air intake areas, stop the engine immediately and clean. Operating the engine with blocked or dirty air intake and cooling areas can cause extensive damage due to overheating.



WARNING: Hot Parts!

Engine components can get extremely hot from operation. To prevent severe burns, do not touch these areas while the engine is running—or immediately after it is turned off. Never operate the engine with heat shields or guards removed.

Engine Speed

NOTE: Do not tamper with the governor setting to increase the maximum engine speed. Overspeed is hazardous and will void the engine warranty.

Maintenance Instructions

Maintenance, repair, or replacement of the emission control devices and systems, which are being done at the customers expense, may be performed by any non-road engine repair establishment or individual. Warranty repairs must be performed by an authorized Kohler service outlet.



WARNING: Accidental Starts!

Disabling engine. Accidental starting can cause severe injury or death. Before working on the engine or equipment, disable the engine as follows: 1) Disconnect the spark plug lead(s). 2) Disconnect negative (-) battery cable from battery.

Maintenance Schedule

These required maintenance procedures should be performed at the frequency stated in the table. They should also be included as part of any seasonal tune-up.

Frequency	Maintenance Required
Daily or Before Starting Engine	<ul style="list-style-type: none">• Fill fuel tank.• Check oil level.• Check air cleaner for dirty¹, loose, or damaged parts.• Check air intake and cooling areas, clean as necessary¹.
Every 2 Months or 25 Hours	<ul style="list-style-type: none">• Service precleaner element¹ (if equipped).• Service air cleaner element¹ (if not equipped with precleaner).
Annually or Every 100 Hours	<ul style="list-style-type: none">• Replace air cleaner element¹ (if equipped with precleaner).• Change oil and filter (refer to Viscosity Table, Page 4, based on seasonal temperatures).• Remove blower housing and clean cooling areas.• Check that all fasteners are in place and components are properly secured.• Replace fuel filter.
Every 2 Years or 200 Hours	<ul style="list-style-type: none">• Check spark plug condition and gap.
Every 200 Hours	<ul style="list-style-type: none">• Have bendix starter drive serviced².• Have valve lash checked/adjusted².
Every 200 to 400 Hours	<ul style="list-style-type: none">• Clean combustion chamber².
Every 500 Hours	<ul style="list-style-type: none">• Replace spark plug.

¹Perform these maintenance procedures more frequently under extremely dusty, dirty conditions.

²Have a Kohler Engine Service Dealer perform this service.

Check Oil Level

The importance of checking and maintaining the proper oil level in the crankcase cannot be overemphasized. Check oil **BEFORE EACH USE** as follows:

1. Make sure the engine is stopped, level, and is cool so the oil has had time to drain into the sump.
2. To keep dirt, grass clippings, etc., out of the engine, clean the area around the oil fill cap/ dipstick before removing it.
3. Pull and remove the oil fill cap/dipstick; wipe oil off. Reinsert the dipstick and push firmly into place. See Figure 6.

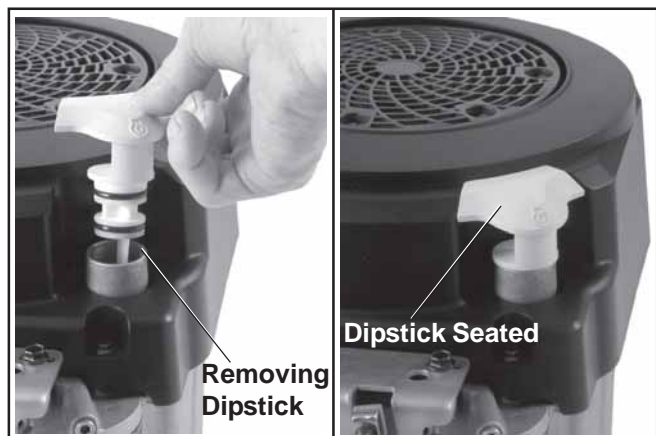

Figure 6. Checking Oil Level.

4. Remove the dipstick and check the oil level.

The oil level should be up to, but not over, the "F" mark on the dipstick. See Figure 7.

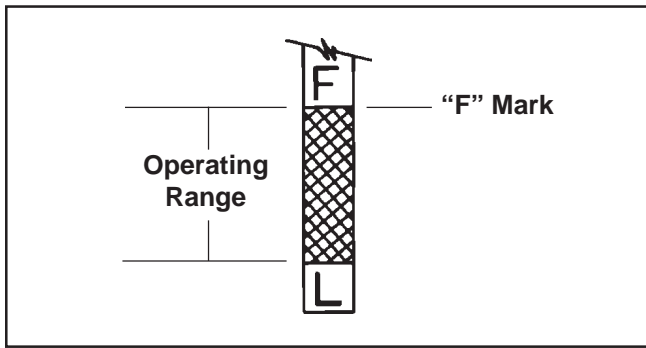

Figure 7. Oil Level Dipstick.

- If the level is low, add oil of the proper type, up to the "F" mark on the dipstick. (Refer to Oil Type on page 4.) Always check the level with the dipstick before adding more oil.

NOTE: To prevent extensive engine wear or damage, always maintain the proper oil level in the crankcase. Never operate the engine with the oil level below the "L" mark or over the "F" mark on the dipstick.

Oil Sentry™

Some engines are equipped with an optional Oil Sentry™ oil pressure switch. See Figure 8. If the oil pressure decreases below an acceptable level, the Oil Sentry™ will either activate a warning signal or shut off the engine, depending on the application.

NOTE: Make sure the oil level is checked **BEFORE EACH USE** and is maintained up to the "F" mark on the dipstick. This includes engines equipped with Oil Sentry™.

Change Oil and Filter

Change the oil and oil filter **annually or every 100 hours** of operation. Refill with service class SG, SH, SJ or higher oil as specified in the Viscosity Grades table (Figure 2) on page 4.

Change the oil and filter while the engine is still warm. The oil will flow more freely and carry away more impurities. Make sure the engine is level when filling, checking, or changing the oil. Always use a genuine Kohler oil filter. Use chart below to determine part number to order.

Oil Filter Part No.	Length
12 050 01-S	2-1/2"
52 050 02-S	3-3/8"

Change the oil and oil filter as follows (see Figure 8):

- To keep dirt, grass clippings, etc., out of the engine, clean the area around the oil fill cap/dipstick before removing it.

- Remove the oil drain plug and oil fill cap/dipstick. Be sure to allow ample time for complete drainage.
- Remove the old filter and wipe off the mounting pad.
- Reinstall the drain plug. Make sure it is tightened to **14 N·m (125 in. lb.)** torque.
- Place the new replacement filter in a shallow pan with the open end up. Pour new oil of the proper type, in through the threaded center hole. Stop pouring when the oil reaches the bottom of the threads. Allow a minute or two for the oil to be absorbed by the filter material.
- Apply a thin film of clean oil to the rubber gasket on the new filter.
- Install the replacement oil filter to the mounting pad. Turn the oil filter until the rubber gasket contacts the pad, then tighten the filter an additional **3/4 to 1 turn**.
- Fill the crankcase, with new oil of the proper type, to the "F" mark on the dipstick. Refer to Oil Type on page 4. Always check the level with the dipstick before adding more oil.
- Reinstall the oil fill cap/dipstick and push firmly into place.
- Test run the engine to check for leaks. Stop the engine, allow a minute for the oil to drain down, and recheck the level on the dipstick. Add more oil, as necessary, so the oil level is up to but not over the "F" mark on the dipstick.

NOTE: To prevent extensive engine wear or damage, always maintain the proper oil level in the crankcase. Never operate the engine with the oil level below the "L" mark or over the "F" mark on the dipstick.

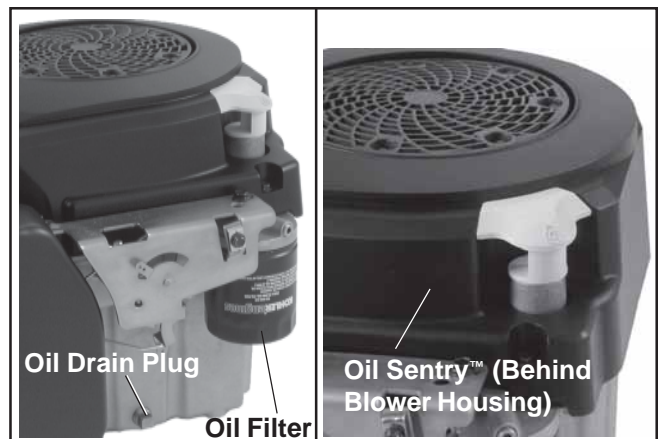

Figure 8. Oil Drain Plug, Oil Filter, and Optional Oil Sentry™ Switch.

Service Precleaner and Air Cleaner Element

This engine is equipped with a replaceable, high density paper air cleaner element. Some engines are also equipped with an oiled, foam precleaner, located in the outer air cleaner cover. See Figure 9.

Check the air cleaner **daily or before starting the engine**. Check for a buildup of dirt and debris around the air cleaner system. Keep this area clean. Also check for loose or damaged components. Replace all bent or damaged air cleaner components.

NOTE: Operating the engine with loose or damaged air cleaner components could allow unfiltered air into the engine causing premature wear and failure.

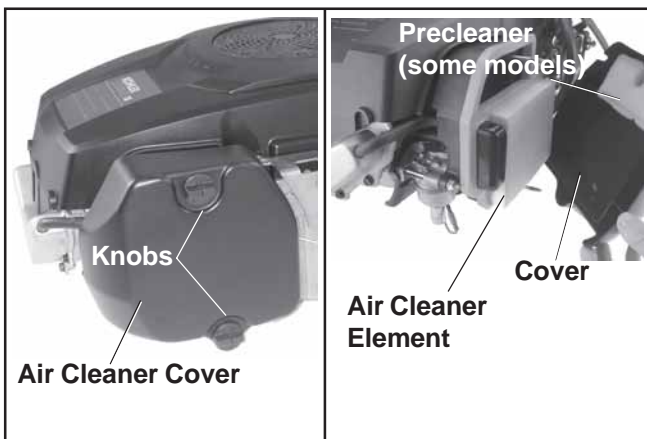

Figure 9. Air Cleaner Assembly - Details.

Service Precleaner

If so equipped, wash and reoil the precleaner **every two months or every 25 hours** of operation, (more often under extremely dusty or dirty conditions).

1. Loosen the air cleaner cover knobs and remove the cover. See Figure 9.
2. Remove the precleaner.
3. Wash the precleaner in warm water with detergent. Rinse the precleaner thoroughly until all traces of detergent are eliminated. Squeeze out excess water (do not wring). Allow the precleaner to air dry.
4. Saturate the precleaner with new engine oil. Squeeze out all excess oil.
5. Reinstall the precleaner into the upper section of the air cleaner cover. Make sure hole in precleaner is aligned with the upper mounting knob.
6. Reinstall the air cleaner cover and secure with the two knobs.

7. When precleaner replacement is necessary order genuine Kohler Part No. 20 083 03-S.

Service Paper Element

Check the paper element **every two months or every 25 hours** of operation, (more often under extremely dusty or dirty conditions). Clean or replace the element as necessary. Replace the air cleaner element **annually**, or **every 100 hours**.

1. Remove the air cleaner cover and the precleaner (if so equipped), service as required. See Figure 9.
2. Remove the air cleaner element with the integral rubber seal. See Figure 10.



Figure 10. Removing Air Cleaner Element.

3. Gently tap the pleated side of the paper element to dislodge dirt. **Do not** wash the paper element or use pressurized air, as this will damage the element. Replace a dirty, bent, or damaged element with a genuine Kohler element. Handle new elements carefully; do not use if the rubber seal is damaged.
4. Clean all air cleaner components of any accumulated dirt or foreign material. Prevent any dirt from entering the throat of carburetor.
5. Install the air cleaner element with the pleated side "out" and seat the rubber seal onto the edges of the air cleaner base. See Figure 11.
6. Reinstall the precleaner (if so equipped), into the upper section of the air cleaner cover. Make sure the hole in precleaner is aligned with the upper mounting knob. See Figure 9.
7. Reinstall the air cleaner cover and secure with the two knobs. See Figure 9.
8. When element replacement is necessary, order Kohler Part No. 20 083 02-S.

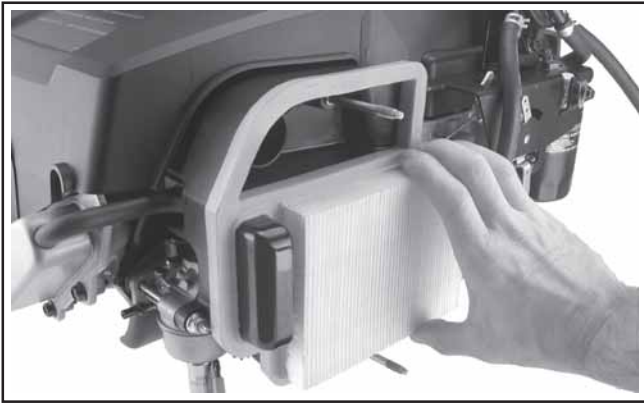

Figure 11. Installing Air Cleaner Element.

Clean Air Intake/Cooling Areas

To ensure proper cooling, make sure the grass screen, cooling fins, and other external surfaces of the engine are kept clean **at all times**.

Annually or every **100 hours** of operation (more often under extremely dusty, dirty conditions), remove the blower housing and any other cooling shrouds. Clean the cooling fins and external surfaces as necessary. Make sure the cooling shrouds are reinstalled. Torque the blower housing screws to **7.5 N·m (65 in. lb.)**.

NOTE: Operating the engine with a blocked grass screen, dirty or plugged cooling fins, and/or cooling shrouds removed, will cause engine damage due to overheating.

Ignition System

This engine is equipped with a dependable electronic CD ignition system. Other than periodically checking/replacing the spark plug, no maintenance, timing, or adjustments are necessary or possible with this system.

In the event starting problems should occur which are not corrected by replacing the spark plug, see your Kohler Engine Service Dealer for trouble analysis.

Check Spark Plug

Every **2 years** or **200 hours** of operation, remove the spark plug, check condition, and reset the gap or replace with a new plug as necessary. The standard spark plug is a Champion® RC12YC (Kohler Part No. 12 132 02-S). RFI compliant engines use a Champion® QC12YC (Kohler Part No. 20 132 02-S) spark plug. A high-performance spark plug, Champion® Platinum 3071 (Kohler Part No. 25 132 12-S) is also available. Equivalent alternate brand plugs can also be used. Spark plug replacement is recommended at **500 hours**.

1. Before removing the spark plug, clean the area around the base of the plug to keep dirt and debris out of the engine.

Due to the deep recess around the spark plug, blowing out the cavity with compressed air is usually the most effective method for cleaning. The spark plug is most accessible when the blower housing is removed for cleaning.

2. Remove the plug and check its condition. Replace the plug if worn or reuse is questionable.

NOTE: Do not clean the spark plug in a machine using abrasive grit. Some grit could remain in the spark plug and enter the engine causing extensive wear and damage.

3. Check the gap using a wire feeler gauge. Adjust the gap by carefully bending the ground electrode. See Figure 12. Gap plugs to **0.76 mm (0.030 in.)**.
4. Reinstall the spark plug into the cylinder head. Torque the spark plug to **24-30 N·m (18-22 ft. lb.)**.
5. Reconnect the spark plug lead and reinstall the blower housing, if removed previously. Torque the blower housing screws to **7.5 N·m (65 in. lb.)**.

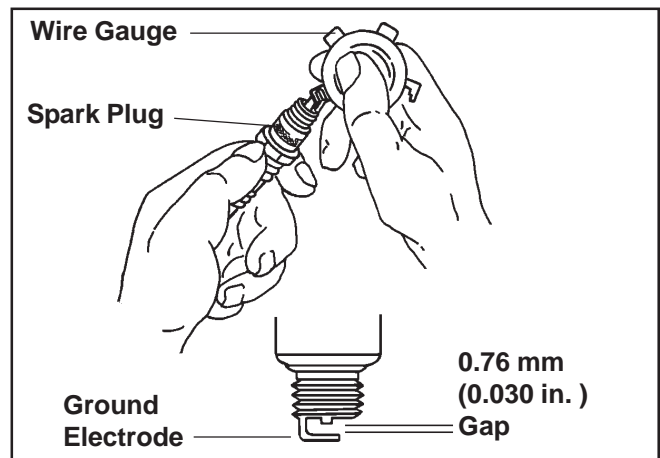

Figure 12. Servicing Spark Plug.

Battery Charging



WARNING: Explosive Gas!

Batteries produce explosive hydrogen gas while being charged. To prevent a fire or explosion, charge batteries only in well ventilated areas. Keep sparks, open flames, and other sources of ignition away from the battery at all times. Keep batteries out of the reach of children. Remove all jewelry when servicing batteries.

Before disconnecting the negative (-) ground cable, make sure all switches are OFF. If ON, a spark will occur at the ground cable terminal which could cause an explosion if hydrogen gas or gasoline vapors are present.

Fuel Filter

Some engines are equipped with an in-line fuel filter. Periodically inspect the filter and replace when dirty. Replacement is recommended **annually or every 100 hours**. Use a genuine Kohler filter.

Fuel Line

In compliance with CARB Tier III Emission Regulations, engines with a **Family** identification number beginning with "6" or greater (see Figure 13), must use Low Permeation SAE 30 R7 rated fuel line; certified to meet CARB requirements. Standard fuel line may not be used. Order replacement hose by part number through a Kohler Engine Service Dealer.

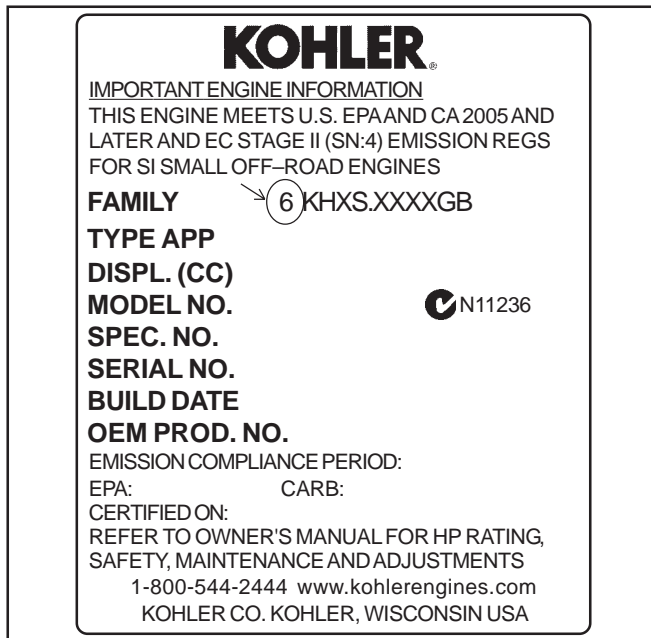

Figure 13. Family Number Location.

Carburetor Troubleshooting and Adjustments

NOTE: Carburetor adjustments should be made only after the engine has warmed up.

These engines are equipped with a Walbro fixed main jet carburetor. See Figure 14. Walbro carburetors have a low idle speed adjustment screw, and either a fixed or low idle fuel adjusting needle with a limiter cap.

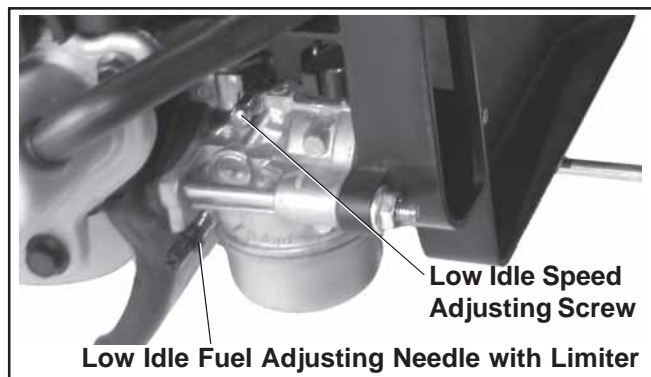

Figure 14. Carburetor.

The carburetor is designed to deliver the correct fuel-to-air mixture to the engine under all operating conditions. The main fuel jet is calibrated at the factory and is not adjustable. The low idle fuel adjusting needle is also set at the factory and normally does not need adjustment.

NOTE: To ensure correct engine operation at altitudes above 1525 meters (5000 ft.), it may be necessary to have an authorized Kohler dealer install a special high-altitude jet kit in the carburetor. If a high-altitude kit has been installed, the engine must be reconverted to the original jet size, before it is operated at lower altitudes, or overheating and engine damage can result.

Troubleshooting

If engine troubles are experienced that appear to be fuel system related, check the following areas before adjusting the carburetor.

- Make sure the fuel tank is filled with clean, fresh gasoline.
- Make sure the fuel tank cap vent is not blocked and that it is operating properly.
- If the fuel tank is equipped with a shut-off valve, make sure it is open.
- If the engine is equipped with an in-line fuel filter, make sure it is clean and unobstructed. Replace the filter if necessary.
- Make sure fuel is reaching the carburetor. This includes checking the fuel lines and fuel pump for restrictions or faulty components, replace as necessary.
- Make sure the air cleaner element is clean and all air cleaner components are fastened securely.

If, after checking the items listed above, the engine is hard to start, runs roughly, or stalls at low idle speed, it may be necessary to adjust or service the carburetor.

Carburetor Adjustment

NOTE: These engines may have a fixed idle or limiter cap on the idle fuel adjusting needle. Step 2 can only be performed within the limits allowed by the cap.

1. Start the engine and run at half throttle for 5 to 10 minutes to warm up. The engine must be warm before doing steps 2 and 3.

2. **Low Idle Fuel Needle Setting:** Place the throttle into the **idle** or **slow** position.

Turn the low idle fuel adjusting needle out (counterclockwise) from the preliminary setting until engine speed decreases (rich). Note the position of the needle.

Now turn the adjusting needle in (clockwise). The engine speed may increase, then it will decrease as the needle is turned in (lean). Note the position of the needle.

Set the adjusting needle midway between the rich and lean settings. See Figure 15.

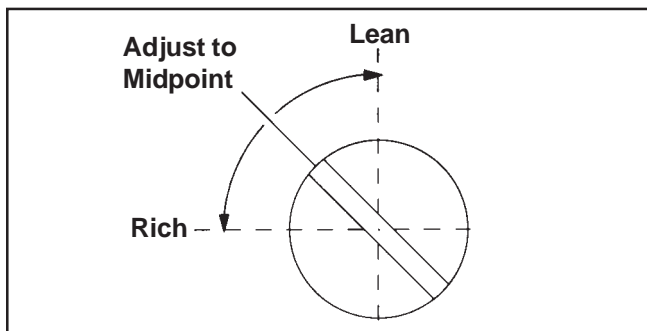

Figure 15. Optimum Low Idle Fuel Setting.

3. **Low Idle Speed Setting:** Place the throttle control into the **idle** or **slow** position. Set the low idle speed to **1500 RPM*** (± 75 RPM) by turning the low idle speed adjusting screw **in or out**. Check the speed using a tachometer.

*NOTE: The actual low idle speed depends on the application – refer to equipment manufacturer’s recommendations. The recommended low idle speed for basic engines is **1500 RPM**. To ensure best results when setting the low idle fuel needle, the low idle speed must not exceed **1500 RPM (± 75 RPM)**.

Troubleshooting

When troubles occur, be sure to check the simple causes which, at first, may seem too obvious to be considered. For example, a starting problem could be caused by an empty fuel tank. Some common causes of engine troubles are listed in the following table.

Do not attempt to service or replace major engine components, or any items that require special timing or adjustment procedures. Have your Kohler Engine Service Dealer do this work.

Possible Cause Problem	No Fuel	Improper Fuel	Dirt In Fuel Line	Dirty Grass Screen	Incorrect Oil Level	Engine Overloaded	Dirty Air Cleaner	Faulty Spark Plug
Will Not Start	•	•	•		•	•	•	•
Hard Starting	•	•	•		•	•	•	•
Stops Suddenly	•		•	•	•	•	•	
Lacks Power		•	•	•	•	•	•	•
Operates Erratically		•	•	•		•	•	•
Knocks or Pings		•		•		•		•
Skips or Misfires		•	•	•			•	•
Backfires			•			•	•	•
Overheats			•	•	•	•	•	
High Fuel Consumption						•	•	•

Storage

If the engine will be out of service for two months or more, use the following storage procedure:

1. Clean the exterior surfaces of the engine.
2. Change the oil and filter while the engine is still warm from operation. See Change Oil and Filter on page 9.
3. The fuel system must be completely emptied, or the gasoline must be treated with a stabilizer to prevent deterioration. If you choose to use a stabilizer, follow the manufacturers recommendations, and add the correct amount for the capacity of the fuel system. Fill the fuel tank with clean, fresh gasoline. Run the engine for 2-3 minutes to get stabilized fuel into the carburetor.

To empty the system, run the engine until the tank and system are empty.

4. Due to the deep recess around the spark plug, blow out the cavity with compressed air. Remove the spark plug. The spark plug is most accessible when the blower housing is removed for cleaning.

Add one tablespoon of engine oil into the spark plug hole. Install the plug, but do not connect the plug lead. Crank the engine two or three revolutions. Connect the plug lead.

5. Reinstall the blower housing, if removed previously, and torque the blower housing screws to **7.5 N·m (65 in. lb.)**.
6. Store the engine in a clean, dry place.

Parts Ordering

The engine Model, Specification, and Serial Numbers are required when ordering replacement parts from your Kohler Engine Service Dealer. These numbers are found on the identification plate which is affixed to the engine shrouding. Include letter suffixes if there are any. See Engine Identification Numbers on page 5.

Always insist on genuine Kohler parts. All genuine Kohler parts meet strict standards for fit, reliability, and performance.

Model Designation

Model SV530S for example: S designates Courage engine, V designates vertical crankshaft, and 530 is the model designation. A letter suffix designates a specific version as follows:

Suffix	Designates
S	Electric Start

Major Repair

Major repair information is available in Kohler Engine Service Manuals. This type of repair generally requires the services of a trained mechanic and the use of special tools and equipment. Kohler Engine Service Dealers have the facilities, training, and genuine Kohler replacement parts necessary to perform this service.

For the nearest Sales & Service location:

- visit our website www.kohlerengines.com
- call 1-800-544-2444 (U.S. & Canada)
- look in the yellow pages under Engines-Gasoline

COURAGE® ENGINE LIMITED WARRANTY

Kohler Co. warrants to the original retail consumer that each new COURAGE® engine sold by Kohler Co. will be free from manufacturing defects in materials or workmanship in normal residential homeowner service for a period of two (2) years from date of purchase, provided it is operated and maintained in accordance with Kohler Co.'s instructions and manuals. If used commercially the COURAGE® engine is covered by a 90 day* limited warranty.

The warranty period begins on the date of purchase by the original retail consumer or commercial end user. "Residential homeowner service" means residential use by a retail consumer. "Commercial use" means all other uses, including use for commercial, or rental purposes. Once in commercial use, the engine will thereafter be considered a commercial use engine for the purposes of this warranty.

Our obligation under this warranty is expressly limited, at our option, to the replacement or repair at Kohler Co., Kohler, Wisconsin 53044, or at a service facility designated by us of such parts as inspection shall disclose to have been defective.

EXCLUSIONS:

Mufflers on engines used commercially (non-residential) are warranted for 90 days from date of purchase.

This warranty does not apply to defects caused by casualty or unreasonable use, including faulty repairs by others and failure to provide reasonable and necessary maintenance.

The following items are not covered by this warranty:

Engine accessories such as fuel tanks, clutches, transmissions, power-drive assemblies, and batteries, unless supplied or installed by Kohler Co. These are subject to the warranties, if any, of their manufacturers.

KOHLER CO. AND/OR THE SELLER SHALL NOT BE LIABLE FOR SPECIAL, INDIRECT, INCIDENTAL, OR CONSEQUENTIAL DAMAGES OF ANY KIND, including but not limited to labor costs or transportation charges in connection with the repair or replacement of defective parts.

IMPLIED OR STATUTORY WARRANTIES, INCLUDING WARRANTIES OF MERCHANTABILITY OR FITNESS FOR A PARTICULAR PURPOSE, ARE EXPRESSLY LIMITED TO THE DURATION OF THIS WRITTEN WARRANTY. We make no other express warranty, nor is any one authorized to make any on our behalf.

Some states do not allow limitations on how long an implied warranty lasts, or the exclusion or limitation of incidental or consequential damages, so the above limitation or exclusion may not apply to you.

This warranty gives you specific legal rights, and you may also have other rights which vary from state to state.

TO OBTAIN WARRANTY SERVICE:

Purchaser must bring the engine to an authorized Kohler service facility. To locate the nearest facility, visit our website, www.kohlerengines.com, and click on DEALER LOCATOR to use the locator function, consult your Yellow Pages or telephone 1-800-544-2444.

ENGINE DIVISION, KOHLER CO., KOHLER, WISCONSIN 53044

*With the exception of countries governed by the European Union (EU), where a one (1) year warranty is required for commercial/professional use.

**KOHLER CO.
FEDERAL AND CALIFORNIA EMISSION CONTROL SYSTEMS
LIMITED WARRANTY
SMALL OFF-ROAD ENGINES**

The U.S. Environmental Protection Agency (EPA), the California Air Resources Board (CARB), and Kohler Co. are pleased to explain the Federal and California Emission Control Systems Warranty on your small off-road equipment engine. In California beginning in 2006, "emissions" means both exhaust and evaporative emissions. For California, engines produced in 2006 and later must be designed, built and equipped to meet the state's stringent anti-smog standards. In other states, 1997 and later model year engines must be designed, built and equipped, to meet the U.S. EPA regulations for small non-road engines. The engine must be free from defects in materials and workmanship which cause it to fail to conform with U.S. EPA standards for the first two years of engine use from the date of sale to the ultimate purchaser. Kohler Co. must warrant the emission control system on the engine for the period of time listed above, provided there has been no abuse, neglect or improper maintenance.

The emission control system may include parts such as the carburetor or fuel injection system, the ignition system, and catalytic converter. Also included are the hoses, belts and connectors and other emission related assemblies.

Where a warrantable condition exists, Kohler Co. will repair the engine at no cost, including diagnosis (if the diagnostic work is performed at an authorized dealer), parts and labor.

MANUFACTURER'S WARRANTY COVERAGE

Engines produced in 2006 or later are warranted for two years in California. In other states, 1997 and later model year engines are warranted for two years. If any emission related part on the engine is defective, the part will be repaired or replaced by Kohler Co. free of charge.

OWNER'S WARRANTY RESPONSIBILITIES

- (a) The engine owner is responsible for the performance of the required maintenance listed in the owner's manual. Kohler Co. recommends that you retain all receipts covering maintenance on the engine, But Kohler Co. cannot deny warranty solely for the lack of receipts or for your failure to assure that all scheduled maintenance was performed.
- (b) Be aware, however, that Kohler Co. may deny warranty coverage if the engine or a part has failed due to abuse, neglect, improper maintenance or unapproved modifications.
- (c) For warranty repairs, the engine must be presented to a Kohler Co. service center as soon as a problem exists. Call 1-800-544-2444 or access our web site at: www.kohlerengines.com, for the names of the nearest service centers. The warranty repairs should be completed in a reasonable amount of time, not to exceed 30 days.

If you have any questions regarding warranty rights and responsibilities, you should contact Kohler Co. at 1-920-457-4441 and ask for an Engine Service representative.

COVERAGE

Kohler Co. warrants to the ultimate purchaser and each subsequent purchaser that the engine will be designed, built and equipped, at the time of sale, to meet all applicable regulations. Kohler Co. also warrants to the initial purchaser and each subsequent purchaser, that the engine is free from defects in materials and workmanship which cause the engine to fail to conform with applicable regulations for a period of two years.

Engines produced in 2006 or later are warranted for two years in California. For 1997 and later model years, EPA requires manufacturers to warrant engines for two years in all other states. These warranty periods will begin on the date the engine is purchased by the initial purchaser. If any emission related part on the engine is defective, the part will be replaced by Kohler Co. at no cost to the owner. Kohler Co. is liable for damages to other engine components caused by the failure of a warranted part still under warranty.

Kohler Co. shall remedy warranty defects at any authorized Kohler Co. engine dealer or warranty station. Warranty repair work done at an authorized dealer or warranty station shall be free of charge to the owner if such work determines that a warranted part is defective.

Continued on next page.

Listed below are the parts covered by the Federal and California Emission Control Systems Warranty. Some parts listed below may require scheduled maintenance and are warranted up to the first scheduled replacement point for that part. The warranted parts include the following if they were present in the engine purchased:

- Oxygen sensor (if equipped)
- Intake manifold (if equipped)
- Exhaust manifold (if equipped)
- Catalytic muffler (if equipped)
- Thermal reactor muffler (if equipped)
- Fuel lines, fuel line fittings and clamps (if equipped)
- Spark advance module (if equipped)
- Crankcase breather
- Air Injection System (if equipped)
 - Air pump or pulse valve assembly (if equipped)
 - Control/distribution valve (if equipped)
 - Distribution manifold (if equipped)
 - Air hoses (if equipped)
 - Vacuum lines (if equipped)
- Ignition module(s) with high tension lead
- Gaseous fuel regulator (if equipped)
- Electronic control unit (if equipped)
- Carburetor or fuel injection system
- Fuel metering valve (if equipped)
- Air filter, fuel filter, and spark plugs (only to first scheduled replacement point)
- Evaporative System (if equipped)
 - Canister (if equipped)
 - Canister filter (if equipped)
 - Vapor hose (if equipped)
 - Orifice connector (if equipped)
 - Fuel tank (if equipped)
 - Fuel cap (if equipped)
 - Primer bulb canister (if equipped)

LIMITATIONS

This Emission Control Systems Warranty shall not cover any of the following:

- (a) repair or replacement required because of misuse or neglect, improper maintenance, repairs improperly performed or replacements not conforming to Kohler Co. specifications that adversely affect performance and/or durability and alterations or modifications not recommended or approved in writing by Kohler Co.,
- (b) replacement of parts and other services and adjustments necessary for required maintenance at and after the first scheduled replacement point,
- (c) consequential damages such as loss of time, inconvenience, loss of use of the engine or equipment, etc.,
- (d) diagnosis and inspection fees that do not result in eligible warranty service being performed, and
- (e) any add-on or modified part, or malfunction of authorized parts due to the use of add-on or modified parts.

MAINTENANCE AND REPAIR REQUIREMENTS

The owner is responsible for the proper use and maintenance of the engine. Kohler Co. recommends that all receipts and records covering the performance of regular maintenance be retained in case questions arise. If the engine is resold during the warranty period, the maintenance records should be transferred to each subsequent owner. Kohler Co. reserves the right to deny warranty coverage if the engine has not been properly maintained; however, Kohler Co. may not deny warranty repairs solely because of the lack of repair maintenance or failure to keep maintenance records.

Normal maintenance, replacement or repair of emission control devices and systems may be performed by any repair establishment or individual; however, **warranty repairs must be performed by a Kohler authorized service center.** Any replacement part or service that is equivalent in performance and durability may be used in non-warranty maintenance or repairs, and shall not reduce the warranty obligations of the engine manufacturer.



FORMNO.:	20 590 01-B
ISSUED:	11/04
REVISED:	3/09

LITHO IN U.S.A.

FOR SALES AND SERVICE INFORMATION
IN U.S. AND CANADA, CALL **1-800-544-2444**

KohlerEngines.com

ENGINE DIVISION, KOHLER CO., KOHLER, WISCONSIN 53044



1P20 590 01-B



6 50531 66675 8