

Power curves are corrected to standard sea level atmospheric condition and are developed from test engines equipped with standard air cleaner and muffler.

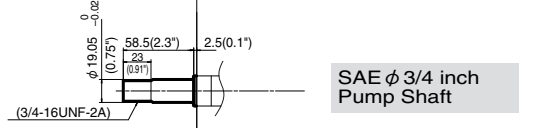
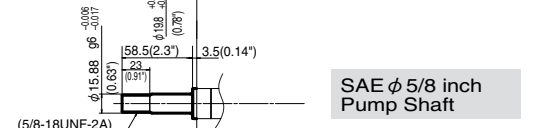
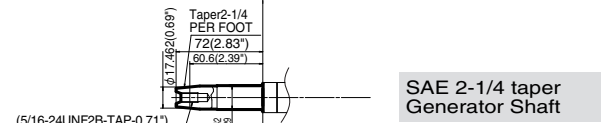
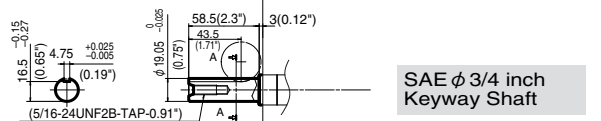
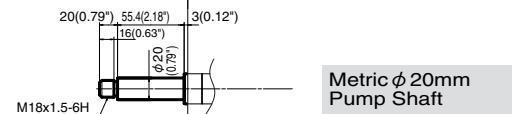
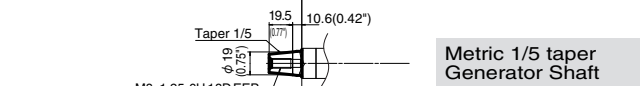
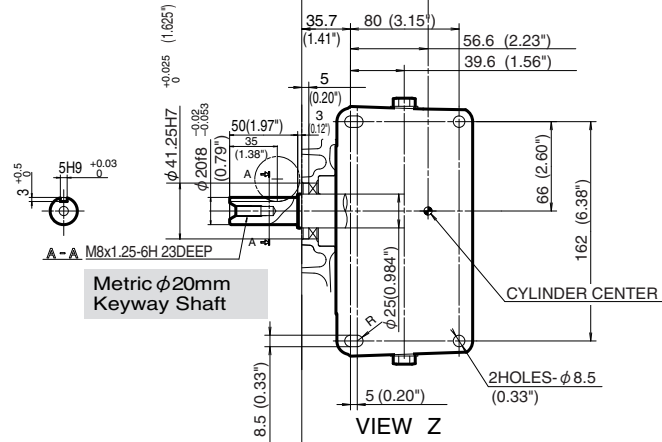

EX21