

Section 1 Safety and General Information

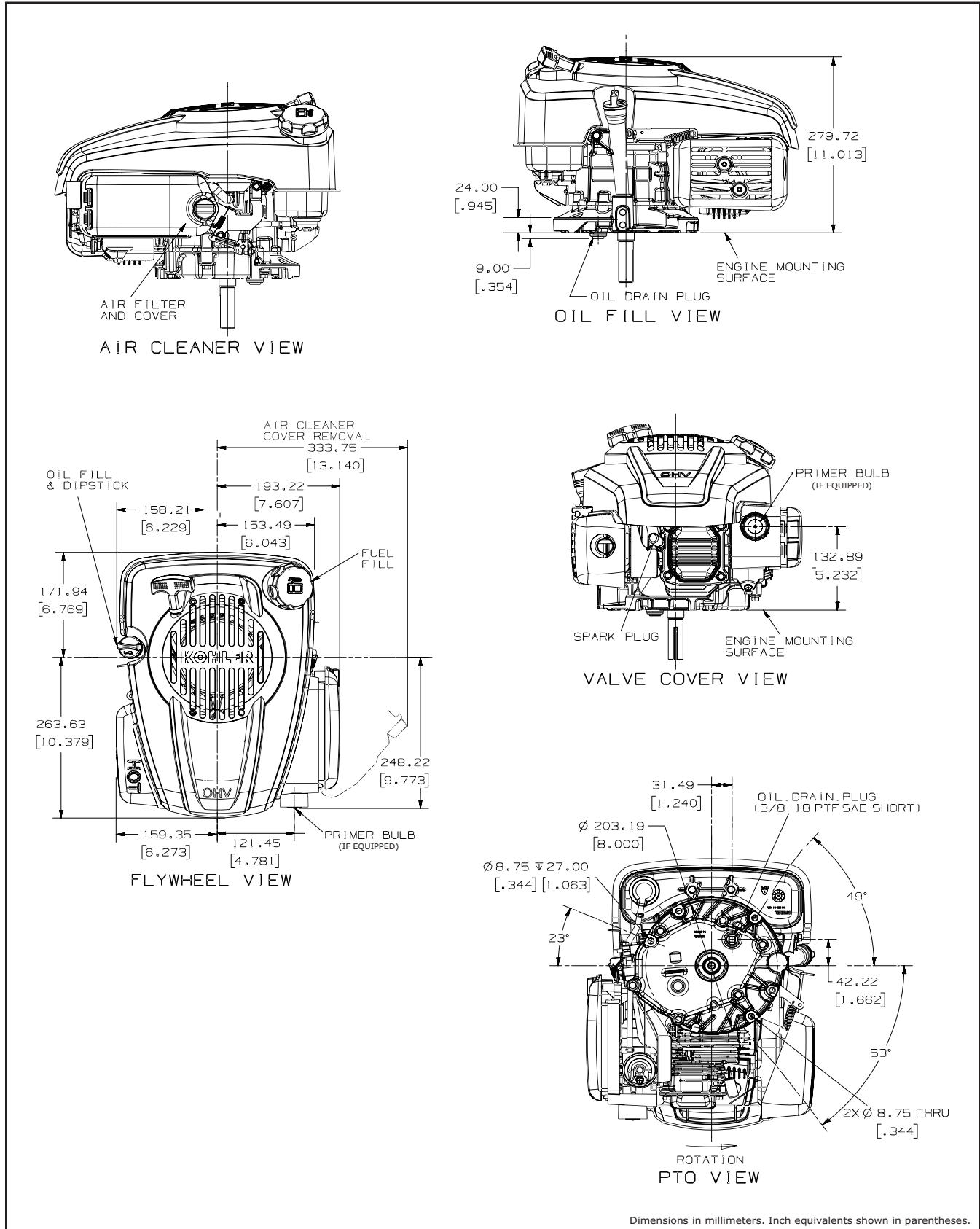

Figure 1-5. Typical Engine Dimensions.